

## WCB CABINET

P/N:WCB

P/N:WCB



### STANDARD

Comply with ANSI/EIA RS-310-D, DIN41491; PART1, IEC297-2, DIN41494; PART7, GB/T3047.2-92 standard.  
Compatible with metric, ETSI and 19' international standard.

### FEATURES

- Exquisite design with precise dimension and craftsmanship.
- International popular smoky-gray glass front door.
- Easily be mounted on wall, or placed on floor after installed castor or feet.
- Loading capacity: 60KG.
- Top and bottom wiring channel could be closed.
- Removable front door and side panel, easily installing and maintaining
- Surface finish: Degreased, acid cleaned, phosphoric, water cleaned, electro-static powder coating, meet ROHS standard.
- Optional color: black/gray
- Optional accessories.

### MATERIALS

Cool rolled steel  
Thickness: Vertical rail:1.5mm  
Else in 1.2mm  
Tempered smoky-gray glass with thickness of 5mm.

### APPLICATION

Widely used in network system, educational system, broadcasting system and telecommunication system. Suitable for placing server computer and precision electronic equipments.



## WCB CABINET

P/N:WCB

### STRUCTURAL

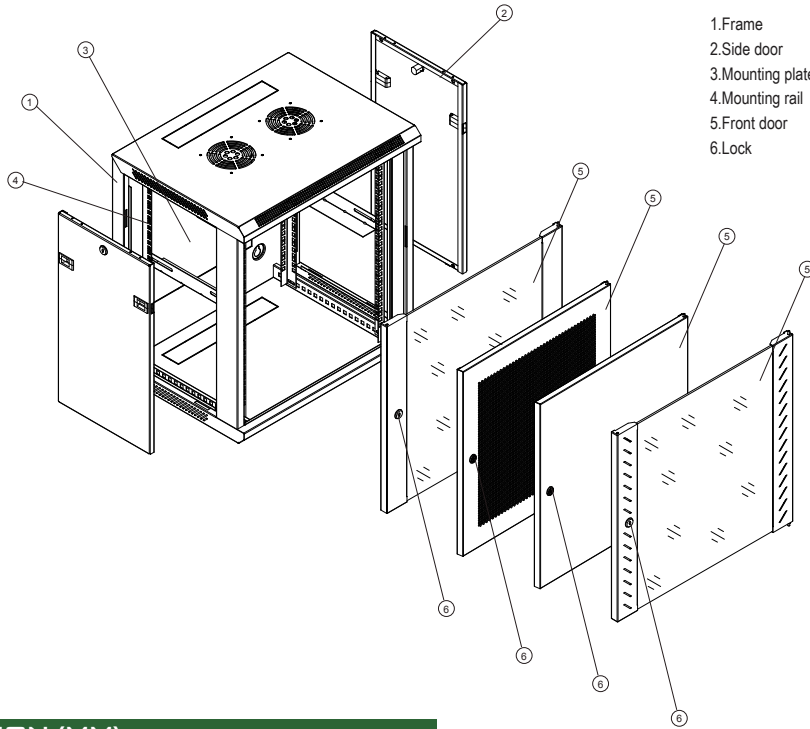

### DIMENSION (MM)

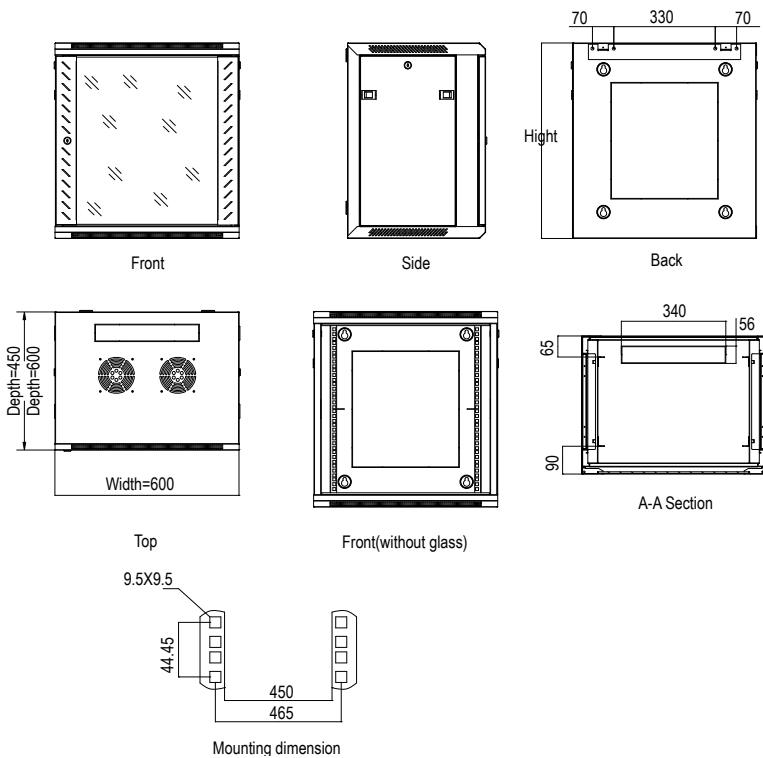

### STRUCTURAL (SPLIT TYPE)

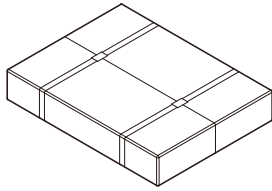

A package(with top/bottom plate)

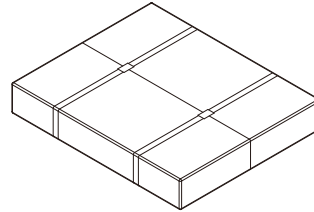
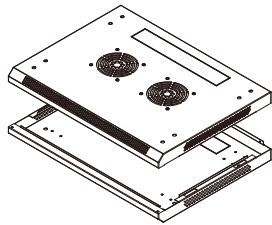

B package(back door, L guide rail, frame, mounting plate, frame holder, support, side door, front door)

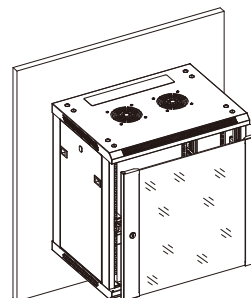
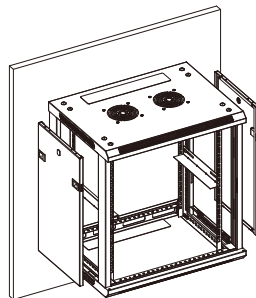
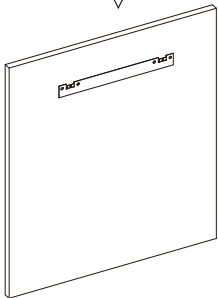
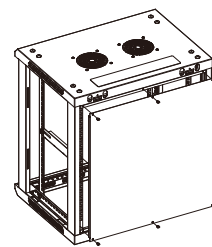
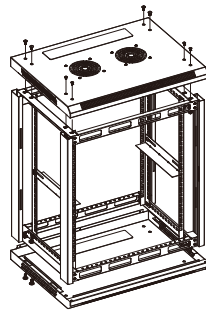
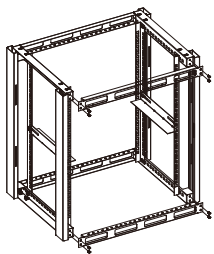
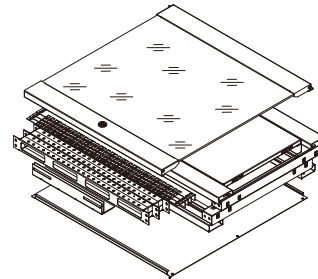

## WCB CABINET

P/N:WCB

### STANDARD ACCESSORIES (WCB)

S/N	Specification	Qty	Unit	Material	surface finish	Remark
1	Frame	2	Pcs	1.2mm cold rolled steel	Powder coated	---
2	Front door	1	Pcs	1.2mm cold rolled steel	---	B type door
3	Side door	2	Pcs	1.2mm cold rolled steel	Powder coated	With lock
4	lock	1	Pcs	---	---	---
5	Mounting rail	4	Pcs	1.5mm cold rolled steel	Powder coated	---
6	Mounting plate	1	Pcs	1.2mm cold rolled steel	Powder coated	---
7	Cable inlet cap	2	Pcs	1.2mm cold rolled steel	Powder coated	---
8	Screws &nuts	10	sets	---	---	---
9	wrench	1	Pcs	---	---	---

### ORDER INFORMATION

Part No	Capacity/U	Width/mm	Depth/mm	Height/mm	Carton measurement			Volume/CBM
					Width/m	Depth/m	Height/m	
WCB06-645-☆☆	6U	600	450	368	0.67	0.52	0.43	0.15
WCB09-645-☆☆	9U	600	450	501	0.67	0.52	0.56	0.20
WCB12-645-☆☆	12U	600	450	635	0.67	0.52	0.70	0.24
WCB15-645-☆☆	15U	600	450	769	0.67	0.52	0.83	0.29
WCB18-645-☆☆	18U	600	450	901	0.67	0.52	0.96	0.33
WCB22-645-☆☆	22U	600	450	1082	0.67	0.52	1.14	0.40
WCB06-66-☆☆	6U	600	600	368	0.67	0.67	0.43	0.19
WCB09-66-☆☆	9U	600	600	501	0.67	0.67	0.56	0.25
WCB12-66-☆☆	12U	600	600	635	0.67	0.67	0.70	0.31
WCB15-66-☆☆	15U	600	600	769	0.67	0.67	0.83	0.37
WCB18-66-☆☆	18U	600	600	901	0.67	0.67	0.96	0.43
WCB22-66-☆☆	22U	600	600	1082	0.67	0.67	1.14	0.51

## WCB CABINET

P/N:WCB

### REMARKS

\* = Front door

### DOORS

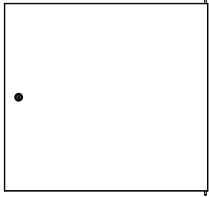

A=Steel Casement Door

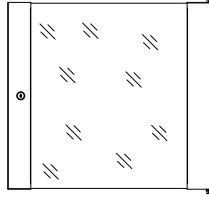

B=Smoky-grey glass door

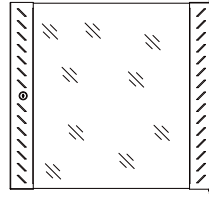

C=Smoky-grey glass door with frame punched

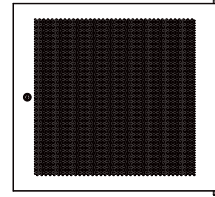

D=Perforation steel door with high ventilation level(hexagonal type)

### COLOR

☆ = Colors

A= Black(RAL9004)

B=Gray(RAL7044)

